



DRIVING

• Screwdriver Bits • Nutsetters • Hex Keys • Hex Screwdrivers

DRIVING

Driving Index

250	GorillaGrip[®] Fold Up Sets	241	Screwdriver Bits Sets
250	GorillaGrip[®] Fold Up Utility & Multi-Packs	235	Screwdriver Bits Slotted
256	Hex Pro TORX [®] & Hex Tip	238	Screwdriver Bits Socket Adaptor
245	L-Wrenches Ball End	227	Screwdriver Bits Supabit, Hex
246	L-Wrenches ColorGuard™ Ball End	230	Screwdriver Bits Supabit, Magnetic Nutsetter
244	L-Wrenches Hex End	226	Screwdriver Bits Supabit, Phillips [®]
246	L-Wrenches ProHold [®] Tip Ball End	231	Screwdriver Bits Supabit, Pressure Fit Nutsetter
247	L-Wrenches Stubby Ball End	228	Screwdriver Bits Supabit, Square Recess
247	L-Wrenches Stubby Double Ball End	230	Screwdriver Bits Supabit, Torsion Nutsetter
248	L-Wrenches TORX [®]	229	Screwdriver Bits Supabit, Torx [®]
248	L-Wrenches TORX [®] Tamper Resistant	242	Screwdriver Bits Technical Information
249	Multi-Packs L-Wrenches & GorillaGrip [®] Fold Up	236	Screwdriver Bits Torx [®]
257	Power Bits Ball End	236	Screwdriver Bits Torx [®] Tamper Resistant
238	Screwdriver Bits Magnetic Bit Holder	237	Screwdriver Bits Tri-Wing [®]
239	Screwdriver Bits Magnetic Screw Guide	225	Screwdriver Bits UltraBit
232	Screwdriver Bits Phillips [®]	254	Screwdrivers Ball End
233	Screwdriver Bits Phillips [®] ACR [®]	255	Screwdrivers TORX [®] Tamper Resistant
233	Screwdriver Bits Phillips [®] Plasterboard Insert Bit	257	Socket Bits Hex End
234	Screwdriver Bits Pozidriv [®]	251	T-Handles Ball End
240	Screwdriver Bits Quickbits [®] - Pivoting Nutsetter	252	T-Handles Hex End
240	Screwdriver Bits Quickbits [®] - Smart Setter	253	T-Handles TORX [®]
239	Screwdriver Bits Quick Change Extension	256	Wing & Flag Tool TORX [®]

sutton®

ULTRA



Scan to watch video

12X LIFE



UltraBit Screwdriver Range

Sutton Tools UltraBits, with impact torsion neck, designed to withstand high torque impact applications.

Features

- Shock Absorber Zone – Impact torsion neck, designed to withstand high torque screwing, lasting 12x longer than standard bits.
- Anti-Breakage – Reinforced joints for a stronger link avoiding breakages.
- Ring Reinforcement – Reinforced screw head ring for longer impact resistance.



Impact

Impact Bits – specifically developed for use with the high-torque output of an impact driver. Look out for the “Impact” logo on the packaging.



Magnetic

All bits are magnetic eliminating frustration and increasing productivity when working at awkward angles or in tight spaces.



Torsion

Shock Absorber Zone – Impact torsion neck, designed to withstand high torque screwing.



Precision Fit

Precise Fit – Avoids slipping and stripping screw heads.



Available in:

Phillips

Square

Torx

Hex





sutton®

ULTRA

Sutton Tools UltraBits, with impact torsion neck, designed to withstand high torque impact applications.



Power Bit
1/4" hex for use in power tools and quick change adapters

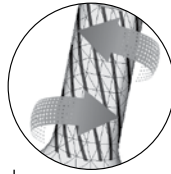

Shock Absorber Zone
Impact torsion neck, designed to withstand high torque screwing, lasting 12x longer than standard bits.

12X LIFE

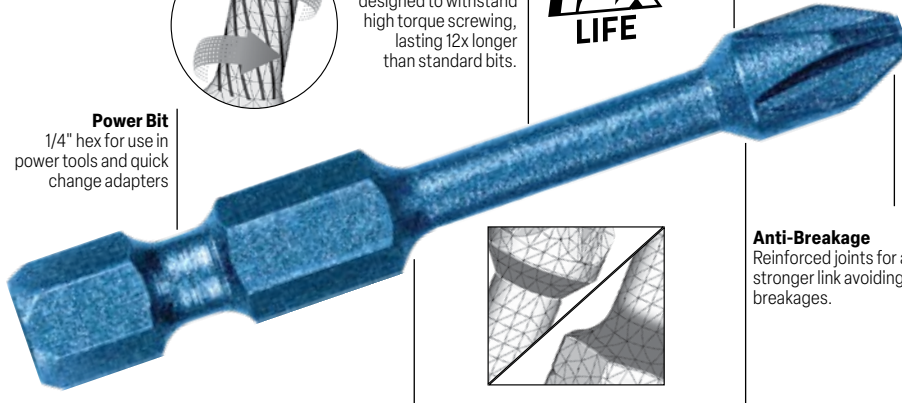

Ring Reinforcement
Reinforced screw head ring for longer impact resistance.



Scan to watch video

Precise Fit
Avoids slipping and stripping screw heads.

Anti-Breakage
Reinforced joints for a stronger link avoiding breakages.

Application

- DIY
- Professional
- Automotive
- Electrical
- Plumbing
- Carpentry
- Plastering

Discount Group: Z0702

Product Information		Item #	Barcode	Item #	Barcode
Description	O/A Length mm		Pieces		
Phillips PH2	50		2	S160 0250	S160 9311963618678
Phillips PH2	50		5	S161 0250	S161 9311963618685
Phillips PH2	50		10	S162 0250	S162 9311963618692
Hex H5	50		2	S163 0550	S163 9311963618708
Hex H5	50		5	S164 0550	S164 9311963618715
Hex H5	50		10	S165 0550	S165 9311963618722
Square R2	50		2	S166 0250	S166 9311963618739
Square R2	50		5	S167 0250	S167 9311963618746
Square R2	50		10	S168 0250	S168 9311963618753
Torx T10	50		2	S169 1050	S169 9311963618760
Torx T15	50		2	S169 1550	9311963618777
Torx T20	50		2	S169 2050	9311963618784
Torx T25	50		2	S169 2550	9311963618791
Torx T30	50		2	S169 3050	9311963618807
Torx T40	50		2	S169 4050	9311963618814



S160 0250



S163 0550



S166 0250



S169 1050



S161 0250



S162 0250





sutton

SUPABIT
EXTREME IMPACT

Torsion Bits

Specifically suited to withstand high torque applications. The elastic property of these bits deliver professional performance that stands up to rigorous use.



Power Bit
1/4" hex for use in impact drivers and quick change adapters

ACR Tip
Anti cam-out rib system reduces stripping and damage to the screw

Torsion Neck
Designed to disperse torsional stress and reduce wear of the screwdriver bit

Insert Bit
1/4" hex for use in bit holders and hand drivers



Application

- DIY
- Trade
- Industrial Application
- Automotive
- Electrical
- Plumbing
- Carpentry
- Plastering
- General Contracting
- Woodworking
- Metalworking
- Machine Shop
- MRO

Discount Group: Z0702

Product Information			Item #	Barcode		Item #	Barcode
Size	O/A Length mm	Pieces	Carded		Order Qty	Bulk Pack	
Insert Bits			S106			S107	
PH1	25	1	S106 0125	9311963441306	10	S107 0125	9311963441337
PH2	25	1	S106 0225	9311963441313	10	S107 0225	9311963441344
PH3	25	1	S106 0325	9311963441320	10	S107 0325	9311963441351
Power Bits							
PH1	50	1	S106 0150	9311963441368	10	S107 0150	9311963441399
PH2	50	1	S106 0250	9311963441375	10	S107 0250	9311963441405
PH3	50	1	S106 0350	9311963441382	10	S107 0350	9311963441412
			S150				
PH2	50	2	S150 0250	9311963608525			
PH2	100	2	S150 02100	9311963608587			
PH2	150	2	S150 02152	9311963608617			
			S151				
PH2	50	5	S151 0250	9311963608532			
PH2	100	5	S151 02100	9311963608594			
PH2	150	5	S151 02152	9311963608624			
Double Ended Bits			S108				
PH2/PH2	50	1	S108 2050	9311963599922			
PH2/PH2	75	1	S108 2070	9311963599939			
PH2/PH2	100	1	S108 2100	9311963599946			
PH2/PH2	150	1	S108 2150	9311963623702			
PH2/PH2	50	6	S108 20506	9311963600000			
PH2/PH2	75	6	S108 20706	9311963600017			
PH2/PH2	100	6	S108 21006	9311963600024			
Double Ended Sets			S105				
PH2/PH2	50	10	S105 1250	9311963570334			
PH2/PH2	75	6	S105 1275	9311963570341			
PH2/PH2	100	6	S105 12100	9311963570358			
Double Ended Sets			S125				
PH2/R2	60	2	S125 1260	9311963623658			
PH2/PH2, R2/R2, PH2/R2	60	3	S125 9360	9311963623665			

Screwdriver Bits Supabit, Hex



sutton

SUPABIT
EXTREME IMPACT



3X
TORQUE

This system is very popular in machine tools and driving deck screws. The vertically sloping side walls of a hex recess screw head prevent the cam-out recess effect.



Power Bit
1/4" hex for use in impact drivers and quick change adapters

Insert Bit
1/4" hex for use in bit holders and hand drivers



Recess Design
Provides better mating with the driver, greater driving surface and minimal metal "fall away"

- Application (Hex)**
- DIY
 - Trade
 - Automotive
 - Furniture
 - Carpentry
 - General Contracting
 - Metalworking
 - Machine Shop
 - MRO

Discount Group: Z0702

Product Information			Item #	Barcode	Item #	Barcode
Size	O/A Length mm	Pieces	Carded	Order Qty	Bulk Pack	
Insert Bits			S114		S115	
H4	25			10	S115 0425	9311963041834
H5	25	1	S114 0525	10	S115 0525	9311963041841
H6	25			10	S115 0625	9311963041858
H8	25			10	S115 0825	9311963041865
Power Bits						
H4	50	1	S114 0450			
H5	50	1	S114 0550	10	S115 0550	9311963049441
H5	75	1	S114 0575	10	S115 0575	9311963439105
H5	100	1	S114 05100	10	S115 05100	9311963439112
			S146			
H5	50	2	S146 0550			
H6	65	2	S146 0665			
H6	100	2	S146 06100			
H5	150	2	S146 05152			
H6	150	2	S146 06150			
			S147			
H5	50	5	S147 0550			
H5	150	5	S147 05152			
5 Pce Set			S114			
H3, H4, H5, H6, H8	50	5	S114 9550			9311963623641

Screwdriver Bits Supabit, Square Recess

sutton

SUPABIT
EXTREME IMPACT



3X
TORQUE

This system is very popular especially for wooden boat building, mobile homes, recreation vehicles and other specialty uses. Also known as a Robertson® bit.

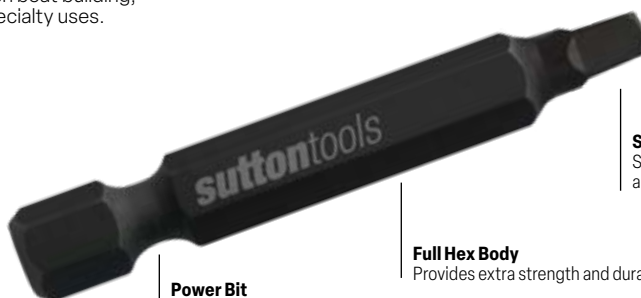

Power Bit
1/4" hex for use in impact drivers and quick change adapters

Full Hex Body
Provides extra strength and durability

Square Recess Tip
Specialised tip design for a number of applications

Insert Bit
1/4" hex for use in bit holders and hand drivers



Application

- Appliances
- Cabinet Making
- Decking
- Trade
- Carpentry
- Plastering
- Woodworking
- HVAC

Discount Group: Z0702

Product Information			Item #	Barcode		Item #	Barcode
Size	O/A Length	Pieces	Carded		Order Qty	Bulk Pack	
	mm						
Insert Bits			S118			S119	
R1	25	2	S118 0125	9311963024691	10	S119 0125	9311963039770
R2	25	2	S118 0225	9311963024707	10	S119 0225	9311963039787
R3	25	2	S118 0325	9311963024721	10	S119 0325	9311963039794
Power Bits							
R1	50	1	S118 0150	9311963024738	10	S119 0150	9311963039800
R2	50	1	S118 0250	9311963024745	10	S119 0250	9311963039817
R3	50	1	S118 0350	9311963024752	10	S119 0350	9311963039824
R2	75				10	S119 0275	9311963039862
R1	90				10	S119 0190	9311963049465
R2	90	1	S118 0290	9311963024769	10	S119 0290	9311963049472
R1	150				10	S119 01150	9311963049489
R2	150	1	S118 02150	9311963024776	10	S119 02150	9311963049649
			S148				
R2	50	2	S148 0250	9311963608426			
R2	150	2	S148 02152	9311963608501			
			S149				
R2	50	5	S149 0250	9311963608433			
R2	150	5	S149 02152	9311963608518			
Single Ended Bits			S119				
R1	100	1	S119 01100	9311963623689			
R3	100	1	S119 03100	9311963623719			
Double Ended Bits							
R2/R2	60	2	S119 1260	9311963623627			
R2/R2	75	6	S119 1275	9311963570365			
R3/R3	75	6	S119 1375	9311963570372			
Double Ended Sets							
R2/H5	60	2	S118 1260	9311963623672			
R1/R1, R2/R2, R3/R3	60	3	S119 9360	9311963623610			

Screwdriver Bits Supabit, Torx®



sutton

SUPABIT
EXTREME IMPACT



Sutton Tools Torx® Supabit screwdriver bits are specifically designed to withstand high torque applications. The elastic property of these bits deliver professional performance that stands up to rigorous use. Provides a greater depth of engagement between the driver and the fastener.



Torsion Neck
For high torque applications

3X Torque
Tested to exceed
DIN standards by
up to 330%

Power Bit
1/4" hex for use in impact
drivers and quick change
adapters

Application (Hex)

- DIY
- Trade
- Automotive
- Furniture
- Carpentry
- General Contracting
- Metalworking
- Machine Shop
- MRO

Discount Group: Z0702

Product Information		Item #	Barcode	Item #	Barcode
Size	O/A Length mm	Carded	Pieces	Bulk Pack	
Power Bits				S153	
T10	50		2	S153 1050	9311963615066
T20	50		2	S153 2050	9311963615073
T25	50		2	S153 2550	9311963615080
T40	50		2	S153 4050	9311963615172
				S154	
T10	50		5	S154 1050	9311963615097
T20	50		5	S154 2050	9311963615103
T25	50		5	S154 2550	9311963615110
Power Bit Set					
T15, T20, T25	50		3	S153 0003	9311963625478



S153 0003



S154 2050

Screwdriver Bits Supabit, Magnetic Nutsetter



Nutsetters are used predominantly in the roofing industry to drive hex head screws.



Power Bit
1/4" hex for use in impact drivers and quick change adapters

High Performance Materials
Delivers professional performance that stands up to rigorous use

Opening
Available for both metric and imperial sizes

Application

- DIY
- Trade
- Automotive
- Electrical
- Plumbing
- Carpentry
- General Contracting
- Woodworking
- Metalworking
- Machine Shop
- MRO

Discount Group: Z0702

Product Information			Item #	Barcode	Item #	Barcode
Size	O/A Length mm	Pieces	Carded	Order Qty	Bulk Pack	
Magnetic Nutsetter – Metric						
8	45			10	S135 0845	S135 9311963051055
10	50			10	S135 1050	S135 9311963051062
Magnetic Nutsetter – Imperial						
			S132			S133
1/4	45	1	S132 0645	9311963074160	10	S133 0645 9311963039893
5/16	45	1	S132 0845	9311963074177	10	S133 0845 9311963039909
3/8	50	1	S132 0950	9311963074184	10	S133 0950 9311963041797
1/4	65	1	S132 0665	9311963074191	10	S133 0665 9311963042015
5/16	65	1	S132 0865	9311963074207	10	S133 0865 9311963042022
3/8	65	1	S132 0965	9311963074214	10	S133 0965 9311963043401
1/4	150	1	S132 06150	9311963518565		
5/16	150	1	S132 08150	9311963518572		
3/8	150	1	S132 09150	9311963518589		
3/8	305	1	S132 09305	9311963623733		
3 Pce Sets						
			S157			
1/4	65	3	S157 0665	9311963626680		
5/16	65	3	S157 0865	9311963626697		
3/8	65	3	S157 0965	9311963626703		
1/4, 5/16, 3/8	65	3	S157 0003	9311963626710		

Screwdriver Bits Supabit, Torsion Nutsetter



Magnetic Nutsetters are used to drive hex head nuts and screws in a wide variety of applications. Supabits withstand high torque applications. The elastic property of these bits deliver professional performance.



Power Bit
1/4" hex for use in impact drivers and quick change adapters

Torsion Neck
Torsion neck zone for high torque applications



Heavy Duty
Self-adjusting spring loaded magnet for heavy duty grip

Discount Group: Z0702

Product Information			Item #	Barcode	Item #	Barcode
Size	O/A Length mm	Pieces				
Torsion Nutsetter						
			S152			
1/4	65	1	S152 0665	9311963611181		
5/16	65	1	S152 0865	9311963611198		
3/8	65	1	S152 0965	9311963611204		

Screwdriver Bits Supabit, Pressure Fit Nutsetter

sutton

SUPABIT
EXTREME IMPACT



Ideal for stainless steel screws and roofing applications. The spring ball locking mechanism eliminates the need for magnets and ensures a tighter fit on the fastener head for stronger, faster driving.



Power Bit
1/4" hex for use in impact drivers and quick change adapters

Chrome Vanadium Steel
& DIN standard

Pressure Fit
Spring-ball locking ensures a tight fit for stronger, faster driving

Discount Group: Z0702

Product Information		Item #	Barcode	Item #	Barcode
Size	O/A Length mm				
Pressure Fit Nutsetter				S158	
5/16	65			S158 0865	9311963635491
3 Pce Set				S159	
5/16	65			S159 0865	9311963635507



S159 0865





sutton

Phillips is the most widely used drive system in the world. The design absorbs torque peak reducing slippage and breakage.

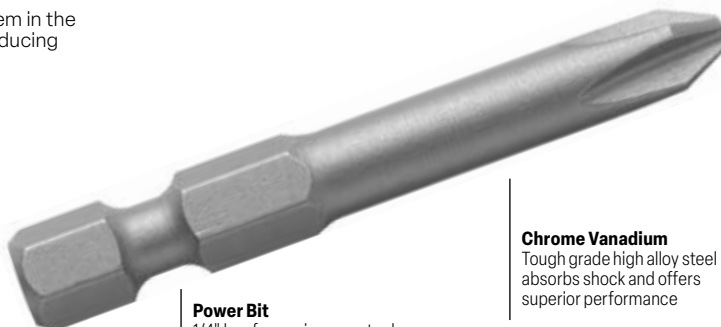

Power Bit
1/4" hex for use in power tools and quick change adapters

Chrome Vanadium
Tough grade high alloy steel absorbs shock and offers superior performance

Insert Bit
1/4" hex for use in bit holders and hand drivers

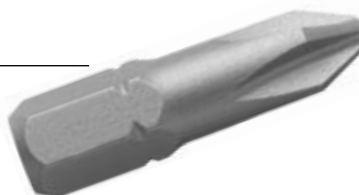

Application

- DIY
- Trade
- Industrial Application
- Automotive
- Electrical
- Plumbing
- Carpentry
- Plastering
- General Contracting
- Woodworking
- Metalworking
- Machine Shop
- MRO

Discount Group: Z0702

Product Information			Item #	Barcode		Item #	Barcode
Size	O/A Length mm	Pieces	Carded		Order Qty	Bulk Pack	
Insert Bits			S104			S105	
PH1	25	1	S104 0125	9311963004198	10	S105 0125	9311963031798
PH2	25	1	S104 0225	9311963005010	10	S105 0225	9311963031804
PH3	25	1	S104 0325	9311963007830	10	S105 0325	9311963031811
PH2 R Reduced	25				10	S105 0225R	9311963031866
Power Bits							
PH1	50	1	S104 0150	9311963072746	10	S105 0150	9311963035284
PH2	50	1	S104 0250	9311963072753	10	S105 0250	9311963035291
PH3	50	1	S104 0350	9311963072760	10	S105 0350	9311963035307
PH2	65	1	S104 0265	9311963570440			
PH2	70	1	S104 2265	9311963570464	10	S105 0270	9311963035321
PH2	90	1	S104 0290	9311963106717	10	S105 0290	9311963035345
PH3	90	1			10	S105 0390	9311963035352
PH1	100	1			10	S105 01100	9311963038759
PH2	100	1	S104 22100	9311963570471	10	S105 02100	9311963039374
PH1	150	1			10	S105 01150	9311963050218
PH2	150	1	S104 02150	9311963179391	10	S105 02150	9311963050027
Double Ended Bits			S122			S125	
PH2/PH2	45	1	S122 0245	9311963106724	10	S125 0245	9311963049892
PH2/PH2	65	1	S122 0265	9311963179377	10	S125 0260	9311963049885
			S104				
PH2/PH2	100	1	S104 12100	9311963570457			
Double Ended Bits - Full Body Hex						S123	
PH2/PH2	110				10	S123 02110	9311963050768
PH2/PH2	150				10	S123 02150	9311963050911
						S127	
PH2/SL6-8	40				10	S127 68240	9311963049229



S105 0225R

Reduced Head
Ideal for use in restricted areas



Double Ended



Double Ended Full Hex Body

Screwdriver Bits Phillips® Plasterboard Insert Bit

sutton

Convert any power drill into a screwgun. Retaining ring notch ideal for even drive depth in plasterboard without tearing.



Retaining Ring Notch
For correct depth alignment

Insert Bit
1/4" hex for use in bit holders and hand drivers

Made With High Hardness S2 Grade Tool Steel

Application
DIY
Trade
General Contracting
Plastering

Discount Group: Z0702

Product Information		Item #	Barcode	Item #	Barcode
Size	O/A Length mm	Carded	Order Qty	Bulk Pack	
Plasterboard Insert Bit				S104	
PH2	25		1	S104 0225D	9311963623726

Screwdriver Bits Phillips® ACR®

sutton



ACR®
Designed to offer extra grip for removal of stubborn or damaged screw recesses.



ACR® Tip
Provides a positive grip on screw recess

Full Hex Body
Provides extra strength and durability

Power Bit
1/4" hex for use in power tools and quick change adapters

Insert Bit
1/4" hex for use in bit holders and hand drivers

Application
DIY
Trade
Industrial Application
Automotive
Electrical
Plumbing
Carpentry
Plastering
General Contracting
Woodworking
Metalworking
Machine Shop
MRO

Discount Group: Z0702

Product Information		Item #	Barcode	Item #	Barcode
Size	O/A Length mm	Carded	Order Qty	Bulk Pack	
Insert Bit				S109	
PH2	25		10	S109 0225	9311963050256
Power Bit					
PH2	50		10	S109 0250	9311963050010



sutton®

The self-centring Pozidriv system provides excellent driving control with less operator fatigue.

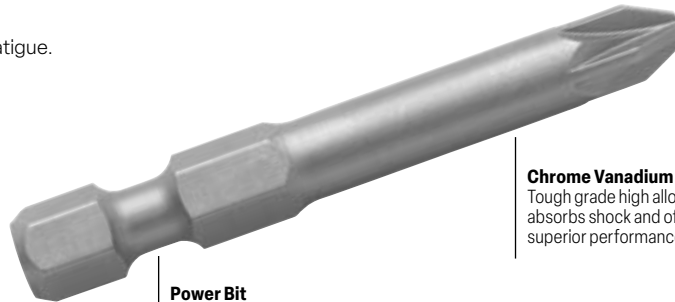

Power Bit
1/4" hex for use in power tools and quick change adapters

Chrome Vanadium
Tough grade high alloy steel absorbs shock and offers superior performance

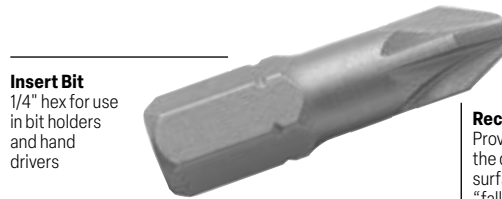

Insert Bit
1/4" hex for use in bit holders and hand drivers

Recess Design
Providing better mating with the driver, greater driving, surface and minimal metal "fall away"

Application

- DIY
- Trade
- Automotive
- Electrical
- Plumbing
- Carpentry
- General Contracting
- Woodworking
- Metalworking
- Machine Shop
- MRO

Discount Group: Z0702

Product Information			Item #	Barcode		Item #	Barcode
Size	O/A Length mm	Pieces	Carded		Order Qty	Bulk Pack	
Insert Bits						S102	
PZ1	25	2	S102 0125	9311963009032	10	S103 0125	9311963031873
PZ2	25	2	S102 0225	9311963009544	10	S103 0225	9311963032030
PZ3	25				10	S103 0325	9311963032078
Power Bits						S103	
PZ1	50	1	S102 0150	9311963072777	10	S103 0150	9311963035628
PZ2	50	1	S102 0250	9311963072784	10	S103 0250	9311963035635
PZ3	50	1	S102 0350	9311963072791	10	S103 0350	9311963036205
PZ1	75				10	S103 0175	9311963039749
PZ2	75				10	S103 0275	9311963039756
PZ3	75				10	S103 0375	9311963039763
PZ1	150				10	S103 01150	9311963037066
PZ2	150				10	S103 02150	9311963037073
PZ3	150				10	S103 03150	9311963037080
Double Ended Bits						S120	
PZ2/PZ2	45	2	S102 0245	9311963570488	10	S103 0245	9311963570495
PZ2/PZ2	65	2	S102 0265	9311963570501	10	S103 0265	9311963570518
PZ2/PZ2	60	1	S120 0260	9311963179384	10	S121 0260	9311963050478

Screwdriver Bits Slotted



sutton

The most popular driving system for general use. For positive drive, the screwdriver tip must be turned 90 degree to align itself with the recess.

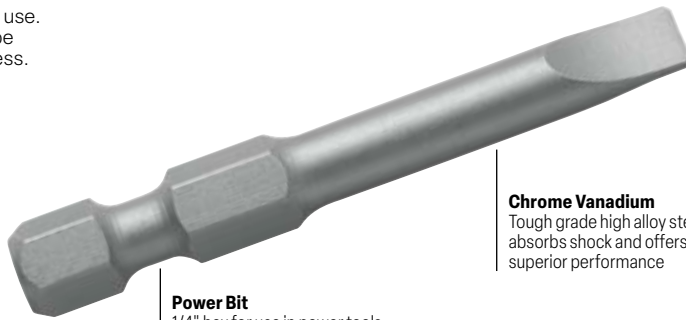

Power Bit
1/4" hex for use in power tools and quick change adapters

Chrome Vanadium
Tough grade high alloy steel absorbs shock and offers superior performance

Insert Bit
1/4" hex for use in bit holders and hand drivers

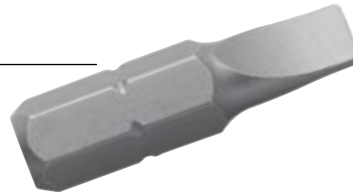

- Application**
- DIY
 - Trade
 - Industrial Application
 - Automotive
 - Electrical
 - Plumbing
 - Carpentry
 - Plastering
 - General Contracting
 - Woodworking
 - Metalworking
 - Machine Shop
 - MRO

Discount Group: Z0702

Product Information			Item #	Barcode		Item #	Barcode
Size	O/A Length mm	Pieces	Carded		Order Qty	Bulk Pack	
Insert Bits			S100			S101	
SL5-6	25	2	S100 5625	9311963005164	10	S101 5625	9311963049373
SL6-8	25	2	S100 6825	9311963005508	10	S101 6825	9311963049380
Power Bits							
SL2-3	50	1	S100 2350	9311963072715			
SL4-5	50	1	S100 4550	9311963570389			
SL5-6	50	1	S100 5650	9311963072722	10	S101 5650	9311963037134
SL6-8	50	1	S100 6850	9311963570396	10	S101 6850	9311963037141
SL8-10	50	1	S100 81050	9311963072739	10	S101 81050	9311963037158
Double Ended Bit						S127	
PH2/SL6-8	40				10	S127 68240	9311963049229

Screwdriver Bits Torx®



sutton

The system provides NO CAM-OUTS because of the straight, vertical side walls in the design of the recessed screw head. Also provides a greater depth of engagement between the driver and the fastener due to the 6 lobes.



Insert Bit
1/4" hex for use in bit holders and hand drivers



Torx® Tip
Popular in automotive and appliance assembly

Application

- DIY
- Trade
- Appliances
- Automotive

Discount Group: Z0702

Product Information			Item #	Barcode		Item #	Barcode
Size	O/A Length mm	Pieces	Carded		Order Qty	Bulk Pack	
Insert Bits – Bulk			S110			S111	
T10	25	2	S110 1025	9311963570402	10	S111 1025	9311963041902
T15	25	2	S110 1530	9311963570419	10	S111 1525	9311963041919
T20	25				10	S111 2025	9311963041926
T25	25	2	S110 2530	9311963570426	10	S111 2525	9311963041933
T27	25	2	S110 2730	9311963570433	10	S111 2725	9311963041940
T30	25				10	S111 3025	9311963041957

Screwdriver Bits Torx® Tamper Resistant



sutton

Tamper resistant bits for the installation and removal of security fasteners.



Insert Bit
1/4" hex for use in bit holders and hand drivers



Torx® Tamper Resistant Tip
Popular in security protection applications

Application

- DIY
- Trade
- Appliances
- Automotive
- Security

Discount Group: Z0702

Product Information			Item #	Barcode		Item #	Barcode
Size	O/A Length mm				Order Qty	Bulk Pack	
Insert Bits – Bulk						S113	
TR10	25				10	S113 1025	9311963044484
TR15	25				10	S113 1525	9311963045085
TR20	25				10	S113 2025	9311963045108
TR25	25				10	S113 2525	9311963045283
TR27	25				10	S113 2725	9311963045405
TR30	25				10	S113 3025	9311963046648



sutton

Tamper resistant bits for the installation and removal of security fasteners.



Insert Bit
1/4" hex for use
in bit holders
and hand
drivers

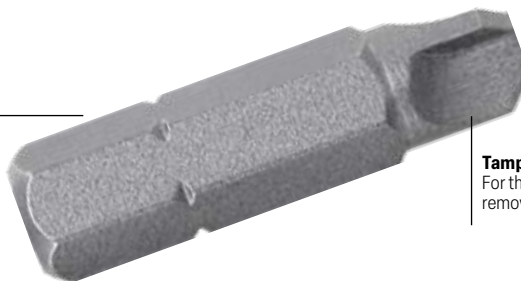

Tamper Resistant Bits
For the installation and
removal of security fasteners

**Application
(Tri Wing)**
Application
Aviation
Electrical/
Electronics
Security

Discount Group: Z0702

Product Information		Item #	Barcode	Item #	Barcode
Size	O/A Length mm		Order Qty	Bulk Pack	
Insert Bits - Bulk				S117	
TW3	25		10	S117 0325	9311963041667
TW4	25		10	S117 0425	9311963041698
TW5	25		10	S117 0525	9311963041742

Screwdriver Bits Socket Adaptor



sutton

For use with a power socket. Ideal for when high torque loads are required.

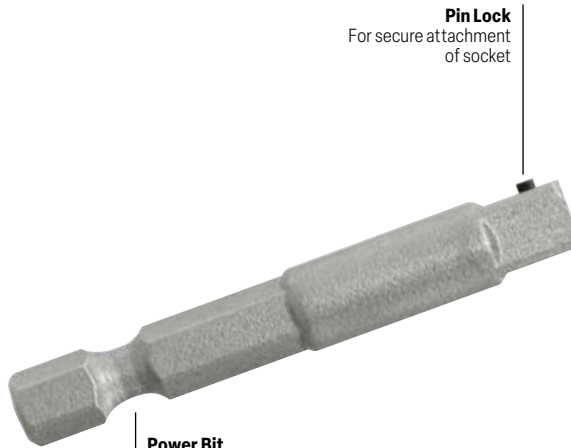
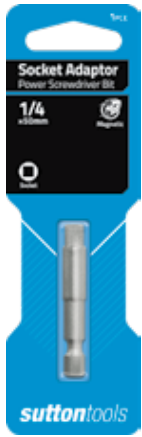

Pin Lock
For secure attachment of socket

Power Bit
1/4" hex for use in power tools and quick change adapters

Application

- DIY
- Trade
- Automotive
- Electrical
- Plumbing
- Carpentry
- General Contracting
- Woodworking
- Metalworking
- Machine Shop
- MRO

Discount Group: Z0702

Product Information			Item #	Barcode	Item #	Barcode
Size	O/A Length mm	Pieces	Carded	Order Qty	Bulk Pack	
Power Bit			S136		S137	
1/4	50	1	S136 0650	9311963439013	10	S137 0650 9311963039916

Screwdriver Bits Magnetic Bit Holder



sutton

Help you change bits faster for greater productivity.

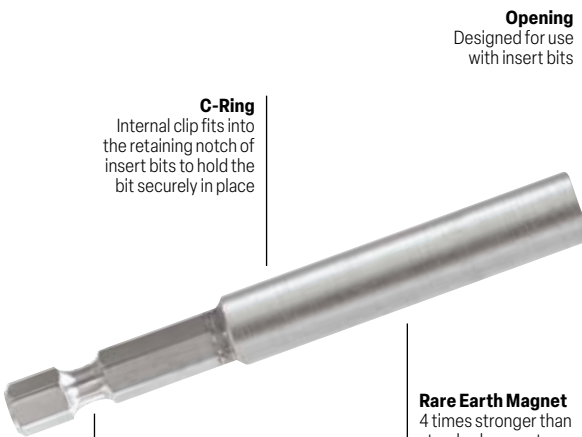

Opening
Designed for use with insert bits

C-Ring
Internal clip fits into the retaining notch of insert bits to hold the bit securely in place

Power Bit
1/4" hex for use in power tools and quick change adapters

Rare Earth Magnet
4 times stronger than standard magnets

Application

- DIY
- Trade
- Industrial Application
- Automotive
- Electrical
- Plumbing
- Carpentry
- Plastering
- General Contracting
- Woodworking
- Metalworking
- Machine Shop
- MRO

Discount Group: Z0702

Product Information			Item #	Barcode	Item #	Barcode
Size	O/A Length mm	Pieces	Carded	Order Qty	Bulk Pack	
Power Bit Holder with C-Ring – Magnetic			S128		S129	
1/4	55			10	S129 0650	9311963049663
1/4	75	1	S128 0675	9311963005171	10	S129 0675 9311963037233

Screwdriver Bits Magnetic Screw Guide



sutton

Designed to hold extra long fasteners in place.



Rare Earth Magnet
4 times stronger than standard magnets firmly holds screw

Power Bit
1/4" hex for use in power tools and quick change adapters

Retracting Sleeve
The guide sleeve retracts as the fastener is driven into the work piece

Discount Group: Z0702

Product Information			Shank Inch	Item #	Barcode
Size	O/A Length mm	Length*			
Power Bit Holder with Retracting Sleeve				S130	
1/4	120	80	1/4	S130 80120	9311963439082
1/4	200	120	1/4	S130 120200	9311963439099
*Length when retracted					

Screwdriver Bits Quick Change Extension



sutton

Suitable for dry-wall installation. The extra strong magnet firmly holds screw in place.



Power Bit
1/4" hex for use in power tools

Rare Earth Magnet
Extra-strong magnet firmly holds screw

Fast Change
One touch ejection of screwdriver bit

Application

- DIY
- Trade
- Automotive
- Electrical
- Plumbing
- Carpentry
- General Contracting
- Woodworking
- Metalworking
- Machine Shop
- MRO

Discount Group: Z0702

Product Information			Shank Inch	Item #	Barcode
Size	O/A Length mm				
Magnetic Extension Bars				S131	
1/4	150		1/4	S131 06150	9311963600291
1/4	300		1/4	S131 06300	9311963600307

Screwdriver Bits Quickbits® - Pivoting Nutsetter



Magnetic Pivoting Nutsetter gives additional access in confined areas with 20° angle rotation.



1/4" Hex Shank
Suits impact drivers and quick change adaptors

Collar
Pull collar forward to pivot, backward to lock



Magnetic Tip
To hold self drilling screws

Discount Group: A0424

Product Information			Item #	Barcode
Size	O/A Length mm	Shank Inch	Pieces	
Magnetic Pivoting Nutsetter Drivers				
1/4	90	1/4	1	107NSP250* 9311744439003
5/16	90	1/4	1	107NSP312 9311744439010
3/8	90	1/4	1	107NSP375 9311744439027
3 Pce Set				
1/4, 5/16, 3/8	90	1/4	3	107NSP003 9311744438990

Screwdriver Bits Quickbits® - Smart Setter

*Not available once current stock is depleted



Smart Setter features adjustable screw depth designed for controlled and uniform screwing on decks, drywall and general fastening without marking the surface or damaging the screw recess. Fits most types of screw bits with 1/4" hex shank.



1/4" Hex Shank
Suits impact drivers and quick change adaptors

Stop Collar
With easy-spin bearing prevents tool from marking the workpiece



Depth Activated Clutch
Stops screw bit drive once desired depth is reached and prevents screw head damage

Adjustable Depth Stop
For accurate control of screw depth

Extra-Wide Gullets
Allow chips to clear without jamming

Discount Group: A0424

Product Information			Item #	Barcode
Description	Contents	Shank Inch	Pieces	
Smart Setter	1 x Smart Setter 5 x 25mm Torsion Insert Bits: 3 x PH2, 1 x H5, 1 x R2	1/4	6	107TDR075 9311744445691

Screwdriver Bits Sets



S138 9360

S138 9550

Discount Group: Z0702

Product Information				Item #	Barcode
Description / Sizes	O/A Length mm	Case	Pieces		
Assorted Sets				S138	
PH1/PH1, PH2/PH2, PH3/PH3	60	Carded	3	S138 9360	9311963623696
PH1, PH2, PH3, R2, H5	50	Carded	5	S138 9550	9311963623634

Popular configuration to suit a variety of applications.
Steel Grade S2 59-62 HRC



S138 0102

S138 0150

S138 0250

S138 0245

S138 0265

S138 0017







S138 0007

S138 0008

Discount Group: Z0702

Product Information			Item #	Barcode
Size	O/A Length mm	Pieces		
Assorted Sets (Plastic Case)			S138	
Screwdriver Phillips Insert Bit				
PH1 & PH2	25	20	S138 0102	9311963439068
Screwdriver Phillips Power Bits - Round Body				
PH1	50	10	S138 0150	9311963439020
PH2	50	10	S138 0250	9311963439037
Screwdriver Phillips Power Bits - Double Ended				
PH2/PH2	45	10	S138 0245	9311963439044
PH2/PH2	65	10	S138 0265	9311963439051
Screwdriver Insert Bits Assorted Set				
Slotted: 4mm, 5mm, 6mm, 7mm Phillips: PH1, PH2, PH3 Pozidriv: PZ1, PZ2, PZ3 Torx: T10, T15, T20, T25, T30, T40 Magnetic Bit Holder 1/4"	60	17	S138 0017	9311963439075
Dial Selector Set				
Phillips: PH1, PH2 Slotted: 4.5mm, 7.0mm Pozidriv: PZ1, PZ2 Magnetic Bit Holder 1/4"	25	7	S138 0007	9311963570525
Belt Clip Set				
Phillips: PH0, PH1, PH2, PH3 Slotted: 4mm, 5mm, 6mm Offset Screwdriver Wrench	25	8	S138 0008	9311963570532

Screwdriver Bits Technical Information

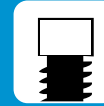
						
Flat	Oval	Round	Button	Truss	Pan	Socket
Installs flush with metal surfaces or countersinks with softer materials for clean appearance.	Used where countersink installation is desired. Rounded head offers deep recess and is visible just above the surface.	Widely used for general purposes. Features a high crown with a deep recess and smaller diameter head than our Truss or Pan Head designs.	Used for general purposes with a lower crown and shallower recess than our Round Head design.	Low profile offers added security against vice-grips removal. Large diameter head for increased fastening strength.	Features a low profile, large diameter head with a high-edged crown for increased strength.	Features a cylindrical head profile allowing for a deeper recess. This style of head is common amongst TORX® and Hex drive systems.

Types of Screw Threads



These types have a locating point with either an A or B thread forming screw thread.



Ideal for applications where no pilot holes are required due to a type AB thread with a self drilling point.



Available in both imperial or metric threads, these screws offer a straight sheared point.

Frequently Asked Questions

Are your screwdriver bits milled or forged?

Our bits are forged for many reasons such as life and performance. This manufacturing process enables our screwdriver bits to have superior performance characteristics against milled equivalents.

What is the difference between an insert bit and a power bit?

The insert bits are commonly used with a magnetic bit holder in a power tool. This combination is economical, provides flexibility and allows a fastener to be magnetically held by the bit. The power bits are placed directly into the drill chuck.

What is ISO-Temp™?

ISO-TEMP™ has been developed to combine both the low wear advantages of extra hard bits and the high elasticity of medium hard bits. This means that ISO-TEMP™ bits ideally suit screw driving in hard materials where high torque peaks need to be counteracted.

Where do I use reduced diameter bits?

In applications for driving screws below the surface of a drywall.

Painted, coated and corroded fasteners provide excessive cam-out, what should I do?

ACR® bits, with their extra grip, are a good solution. ACR® bits are available in both insert and power drives.

How do I identify between Phillips® and Pozidriv® bits?

The shallow 'cross' indentations in the screw head identify a Pozidriv® fastener. The Pozidriv® bit and recess design provides more surface contact between the bit and the screw head than a standard Phillips®. Therefore, the Pozidriv® allows you to apply more torque, reduce the possibility of cam-out. Another way to distinguish the difference is that a Pozidriv® bit can drive a Phillips® screw (but not recommended), whilst a Phillips® bit will struggle to drive a Pozidriv® screw.

Registered Trademarks:

ACR, PHILLIPS, POZIDRIV, TORQ-SET and TRI-WING are registered trademarks of the Phillips Screw Company. TORX and TORX-ALIGN are registered trademarks of Camcar Division of Textron.

Usage By Industry

	Automotive	Aviation	Appliance	Furniture	Construction/ Decking	Public Transport	Electronics	Rec/Hobby	Marine	Security	Drywall/ Subfloor	Machine Tools/ Metal
Phillips®	•	•	•	•	•	•	•	•	•		•	
Slotted	•	•	•	•	•	•	•	•	•			
Torx®	•		•				•					
Tamper Resistant	•		•			•	•			•		
Torq-Set®		•								•		
Tri-Wing®		•								•		
Pozidriv®	•	•	•	•	•	•	•	•	•		•	
Square			•	•						•		
Frearson								•				
Torx-Align®	•		•			•						
Hex	•											•



QUALITY HEX KEYS

Proudly distributed by

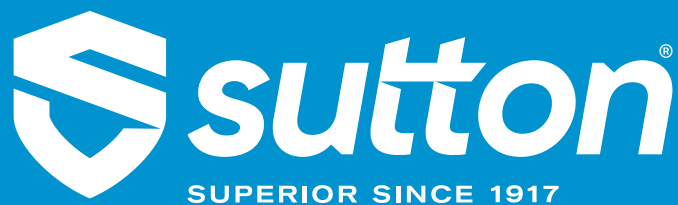

L-Wrenches Hex End



Chamfered tool tips eliminate burrs and help tools seat in screw head.
 Sharp corners transfer more torque to the screw and reduce stripping.
 Precision machined for ease of use and superior fit.



BD12199

BD12137

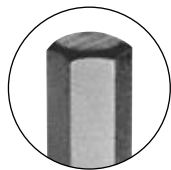

Hex End Tips
 Precision machined for superior fit



Up to 20% stronger, with more torque and higher wear resistance than standard steel



Environmentally safe finish for better corrosion resistance and grip



Chamfered Hex Tip
 For faster insertion and full tool engagement in the screw head

Discount Group: Z1501

Product Information				Item #	Barcode
Size	O/A Length	Arm Length	Pieces		
mm	mm	mm			
Metric (Long) (Tagged)					
1.5	77	14	1	BD15950	037231159504
2.0	82	16	1	BD15952	037231159528
2.5	88	17	1	BD15954	037231159542
3.0	98	19	1	BD15956	037231159566
4.0	110	22	1	BD15960	037231159603
4.5	114	25	1	BD15962	037231159627
5.0	119	27	1	BD15964	037231159641
6.0	139	21	1	BD15968	037231159689
8.0	152	35	1	BD15972	037231159726
9.0	159	27	1	BD15974	037231159740
10.0	171	39	1	BD15976	037231159764
12.0	220	44	1	BD15980	037231159801
14.0	260	55	1	BD15984	037231159849
17.0	280	61	1	BD15986	037231159863
19.0	295	69	1	BD15988	037231159887
Metric (Short) (Tagged)					
.71	31	6	1	BD15847	037231158477
.89	31	9	1	BD15848	037231158484
1.27	42	13	1	BD15849	037231158491
1.5	44	14	1	BD15850	037231158507
2.0	49	16	1	BD15852	037231158521
2.5	54	17	1	BD15854	037231158545
3.0	61	19	1	BD15856	037231158569
3.5	65	21	1	BD15858	037231158583
4.0	68	22	1	BD15860	037231158606
4.5	73	25	1	BD15862	037231158620
5.0	78	27	1	BD15864	037231158644
5.5	83	29	1	BD15866	037231158668
6.0	88	31	1	BD15868	037231158682
7.0	93	33	1	BD15870	037231158705
8.0	98	35	1	BD15872	037231158729
9.0	102	37	1	BD15874	037231158743
10.0	109	39	1	BD15876	037231158767
11.0	115	42	1	BD15878	037231158781
12.0	122	42	1	BD15880	037231158804
14.0	136	55	1	BD15884	037231158842
17.0	156	61	1	BD15886	037231158866
19.0	175	69	1	BD15888	037231158880
Metric Sets					
9 Pce Set (Long): 1.5, 2, 2.5, 3, 4, 5, 6, 8, 10mm			9	BD12199	037231121990
6 Pce Set (Short): 1.5, 2, 2.5, 3, 4, 5mm			6	BD12246	037231122461
9 Pce Set (Short): 1.5, 2, 2.5, 3, 4, 5, 6, 8, 10mm			9	BD12299	037231122997
10 Pce Wallet Set (Short): 1.3, 1.5, 2, 2.5, 3, 4, 5, 6, 8, 10mm			10	BD00009	9314244000094

Product Information				Item #	Barcode
Size	O/A Length	Arm Length	Pieces		
Inch	mm	mm			
Imperial (Long) (Tagged)					
.028"	66	6	1	BD15900	037231159009
.035"	68	9	1	BD15901	037231159016
.050"	72	13	1	BD15902	037231159023
1/16"	76	14	1	BD15903	037231159030
5/64"	81	15	1	BD15904	037231159047
3/32"	86	16	1	BD15905	037231159054
7/64"	90	18	1	BD15906	037231159061
1/8"	95	19	1	BD15907	037231159078
9/64"	101	20	1	BD15908	037231159085
5/32"	107	21	1	BD15909	037231159092
3/16"	114	24	1	BD15910	037231159108
7/32"	124	26	1	BD15911	037231159115
1/4"	133	29	1	BD15912	037231159122
5/16"	152	32	1	BD15913	037231159139
3/8"	171	35	1	BD15914	037231159146
7/16"	191	38	1	BD15915	037231159153
1/2"	210	41	1	BD15916	037231159160
9/16"	229	44	1	BD15917	037231159177
5/8"	248	48	1	BD15918	037231159184
3/4"	286	54	1	BD15919	037231159191
Imperial (Long) (Packaged)					
7/8"	322	60	1	BD12120	037231121204
1"	359	67	1	BD12121	037231121211
Imperial (Short) (Tagged)					
.028"	31	6	1	BD15800	037231158002
.035"	31	9	1	BD15801	037231158019
.050"	42	13	1	BD15802	037231158026
1/16"	45	14	1	BD15803	037231158033
5/64"	48	15	1	BD15804	037231158040
3/32"	51	16	1	BD15805	037231158057
7/64"	54	18	1	BD15806	037231158064
1/8"	58	19	1	BD15807	037231158071
9/64"	61	20	1	BD15808	037231158088
5/32"	64	21	1	BD15809	037231158095
3/16"	70	24	1	BD15810	037231158101
7/32"	77	26	1	BD15811	037231158118
1/4"	83	29	1	BD15812	037231158125
5/16"	96	32	1	BD15813	037231158132
3/8"	108	35	1	BD15814	037231158149
7/16"	121	38	1	BD15815	037231158156
1/2"	133	41	1	BD15816	037231158163
9/16"	146	44	1	BD15817	037231158170
5/8"	159	48	1	BD15818	037231158187
3/4"	184	54	1	BD15819	037231158194
Imperial Sets					
13 Pce Set (Long): .050, 1/16, 5/64, 3/32, 7/64, 1/8, 9/64, 5/32, 3/16, 7/32, 1/4, 5/16, 3/8"			13	BD12137	037231121372
7 Pce Set (Short): 5/64, 3/32, 7/64, 1/8, 9/64, 5/32, 3/16"			7	BD12245	037231122454
13 Pce Set (Short): .050, 1/16, 5/64, 3/32, 7/64, 1/8, 9/64, 5/32, 3/16, 7/32, 1/4, 5/16, 3/8"			13	BD12237	037231122379
10 Pce Wallet Set (Short): 1/16, 5/64, 3/32, 1/8, 5/32, 3/16, 7/32, 1/4, 5/16, 3/8"			10	BD00008	9314244000087

L-Wrenches Ball End



Ball End inserts into a screw at a 25° angle.
 Ball End saves time by quickly funnelling tool into screw.
 25° angle allows natural hand and wrist movement.
 Superior Ball End strength and working angle.
 Works in hard to reach places.



BD10999

BD10938



Ball End Tips
 25° working angle for quick funnelling into screw



Up to 20% stronger, with more torque and higher wear resistance than standard steel

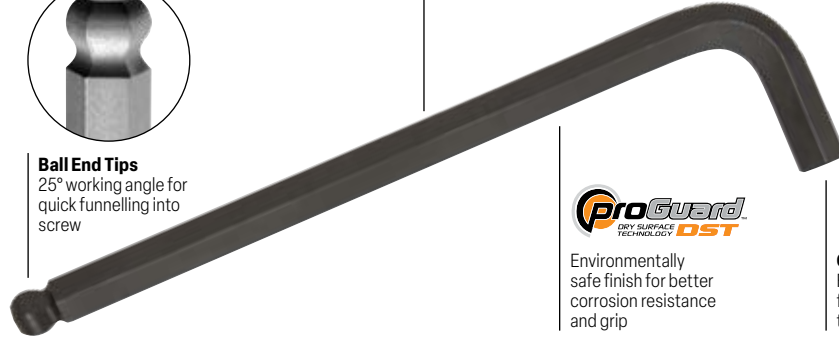

Environmentally safe finish for better corrosion resistance and grip

Chamfered Hex Tip
 For faster insertion and full tool engagement in the screw head

Discount Group: Z1501

Product Information				Item #	Barcode
Size	O/A Length	Arm Length	Pieces		
mm	mm	mm			
Metric (Tagged)					
1.27	72	13	1	BD15749	037231157494
1.5	77	14	1	BD15750	037231157500
2.0	82	16	1	BD15752	037231157524
2.5	88	17	1	BD15754	037231157548
3.0	98	19	1	BD15756	037231157562
3.5	100	21	1	BD15758	037231157586
4.0	110	22	1	BD15760	037231157609
4.5	114	25	1	BD15762	037231157623
5.0	119	27	1	BD15764	037231157647
5.5	124	29	1	BD15766	037231157661
6.0	139	31	1	BD15768	037231157685
7.0	140	33	1	BD15770	037231157708
8.0	152	35	1	BD15772	037231157722
9.0	159	37	1	BD15774	037231157746
10.0	171	39	1	BD15776	037231157760
12.0	220	44	1	BD15780	037231157807
14.0	260	55	1	BD15784	037231157845
17.0	280	61	1	BD15786	037231157869
19.0	295	69	1	BD15788	037231157883
Metric Sets					
6 Pce Set: 1.5, 2, 2.5, 3, 4, 5mm			6	BD10946	037231109462
9 Pce Set: 1.5, 2, 2.5, 3, 4, 5, 6, 8, 10mm			9	BD10999	037231109998
9 Pce Set: 1.5, 2, 2.5, 3, 4, 5, 6, 8, 10mm + Screw Grab Friction Drops 15ml			9	BD14199	037231141998
9 Pce Set (Extra Long): 1.5, 2, 2.5, 3, 4, 5, 6, 8, 10mm			9	BD16099	037231160999
15 Pce Set: 1.27, 1.5, 2, 2.5, 3, 3.5, 4, 4.5, 5, 5.5, 6, 7, 8, 9, 10mm			15	BD10995	037231109950

Product Information				Item #	Barcode
Size	O/A Length	Arm Length	Pieces		
Inch	mm	mm			
Imperial (Tagged)					
.050"	72	13	1	BD15702	037231157029
1/16"	76	14	1	BD15703	037231157036
5/64"	81	15	1	BD15704	037231157043
3/32"	86	16	1	BD15705	037231157050
7/64"	90	18	1	BD15706	037231157067
1/8"	95	19	1	BD15707	037231157074
9/64"	101	20	1	BD15708	037231157081
5/32"	107	21	1	BD15709	037231157098
3/16"	114	24	1	BD15710	037231157104
7/32"	124	26	1	BD15711	037231157111
1/4"	141	29	1	BD15712	037231157128
5/16"	152	32	1	BD15713	037231157135
3/8"	171	35	1	BD15714	037231157142
7/16"	191	38	1	BD15715	037231157159
1/2"	210	41	1	BD15716	037231157166
9/16"	229	44	1	BD15717	037231157173
5/8"	248	48	1	BD15718	037231157180
3/4"	286	54	1	BD15719	037231157197
Imperial Sets					
8 Pce Set: .050, 1/16, 5/64, 3/32, 7/64, 1/8, 9/64, 5/32"			8	BD10932	037231109325
7 Pce Set: 5/64, 3/32, 7/64, 1/8, 9/64, 5/32, 3/16"			7	BD10945	037231109455
10 Pce Set: 1/16, 5/64, 3/32, 7/64, 1/8, 9/64, 5/32, 3/16, 7/32, 1/4"			10	BD10938	037231109387
13 Pce Set: .050, 1/16, 5/64, 3/32, 7/64, 1/8, 9/64, 5/32, 3/16, 7/32, 1/4, 5/16, 3/8"			13	BD10937	037231109370
13 Pce Set (Extra Long): .050, 1/16, 5/64, 3/32, 7/64, 1/8, 9/64, 5/32, 3/16, 7/32, 1/4, 5/16, 3/8"			13	BD16037	037231160371

L-Wrenches ColorGuard™ Ball End



Color-coded tools can be distinguished at a glance.
Superior rust protection finish.
Sizes are stamped on the tool.
Ball End inserts into screw at a 25° angle.



Ball End Tips
25° working angle for quick funnelling into screw



Up to 20% stronger, with more torque and higher wear resistance than standard steel

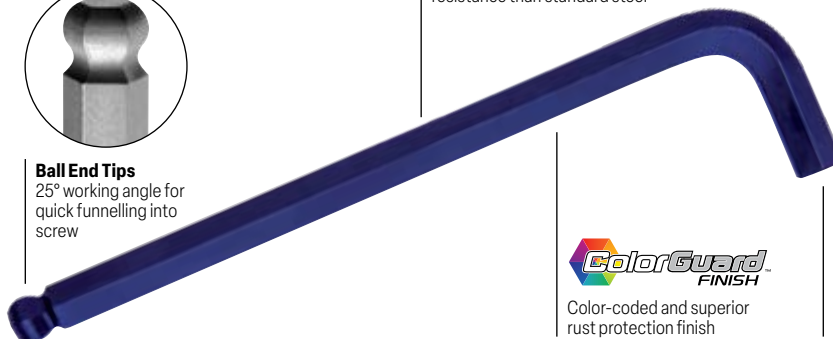

Color-coded and superior rust protection finish

Chamfered Hex Tip
For faster insertion and full tool engagement in the screw head

BD69499 BD69637

Discount Group: Z1501

Product Information		Item #	Barcode
Size	Pieces		
Metric Set 9 Pce Set: 1.5, 2, 2.5, 3, 4, 5, 6, 8, 10mm	9	BD69499	037231694999
Combo Set 22 Pce Set: 9 Pce Metric & 13 Pce	22	BD69600	037231696009

Product Information		Item #	Barcode
Size	Pieces		
Imperial Set 13 Pce Set: .050, 1/16, 5/64, 3/32, 7/64, 1/8, 9/64, 5/32, 3/16, 7/32, 1/4, 5/16, 3/8"	13	BD69637	037231696375

L-Wrenches ProHold® Tip Ball End



BD74992

BD74937

Non-magnetic button holds screw tight on the tool every time.
Super smooth rotational action.
Tool strength is not compromised by the Prohold® button.

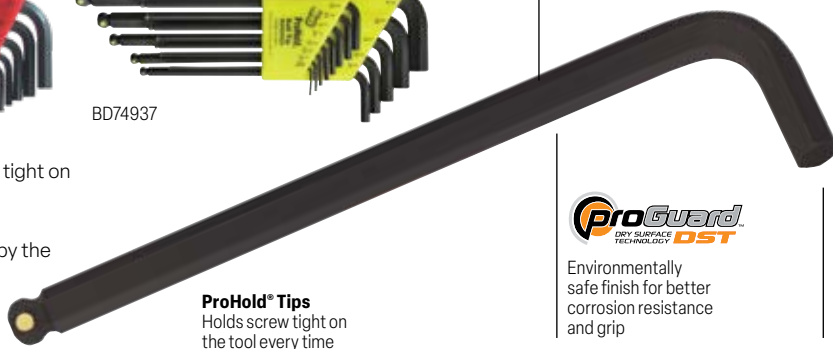

ProHold® Tips
Holds screw tight on the tool every time

Up to 20% stronger, with more torque and higher wear resistance than standard steel



Environmentally safe finish for better corrosion resistance and grip

Chamfered Hex Tip
For faster insertion and full tool engagement in the screw head

Discount Group: Z1501

Product Information				Item #	Barcode
Size	O/A Length	Arm Length	Pieces		
mm	mm	mm			
Metric (Tagged)					
1.27	72	13	1	BD75749	037231757496
1.5	77	14	1	BD75750	037231757502
2.0	82	16	1	BD75752	037231757526
2.5	88	17	1	BD75754	037231757540
3.0	98	19	1	BD75756	037231757564
4.0	110	22	1	BD75760	037231757601
5.0	119	27	1	BD75764	037231757649
6.0	139	31	1	BD75768	037231757687
8.0	152	35	1	BD75772	037231757724
10.0	171	39	1	BD75776	037231757762
Metric Sets					
7 Pce Set (Long): 1.5, 2, 2.5, 3, 4, 5, 6mm			7	BD74992	037231749927
9 Pce Set (Long): 1.5, 2, 2.5, 3, 4, 5, 6, 8, 10mm			9	BD74999	037231749996

Product Information				Item #	Barcode
Size	O/A Length	Arm Length	Pieces		
Inch	mm	mm			
Imperial (Tagged)					
1/16"	76	14	1	BD75703	037231757038
5/64"	81	15	1	BD75704	037231757045
3/32"	86	16	1	BD75705	037231757052
1/8"	95	19	1	BD75707	037231757076
9/64"	101	20	1	BD75708	037231757083
5/32"	107	21	1	BD75709	037231757090
3/16"	114	24	1	BD75710	037231757106
7/32"	124	26	1	BD75711	037231757113
1/4"	141	29	1	BD75712	037231757120
5/16"	152	32	1	BD75713	037231757137
3/8"	171	35	1	BD75714	037231757144
Imperial Sets					
10 Pce Set (Long): 1/16, 5/64, 3/32, 7/64, 1/8, 9/64, 5/32, 3/16, 7/32, 1/4"			10	BD74938	037231749385
13 Pce Set (Long): .050, 1/16, 5/64, 3/32, 7/64, 1/8, 9/64, 5/32, 3/16, 7/32, 1/4, 5/16, 3/8"			13	BD74937	037231749378

L-Wrenches Stubby Ball End



Fits into tight spaces standard hex keys cannot. Eliminates the need to trim and file the short arm. Tighter inside radius means full smooth entry into screw head. Chamfered short arm eliminates burrs. Ball End inserts into a screw at a 25° angle.



BD16599 BD16538



Ball End Tips
25° working angle for quick funnelling into screw

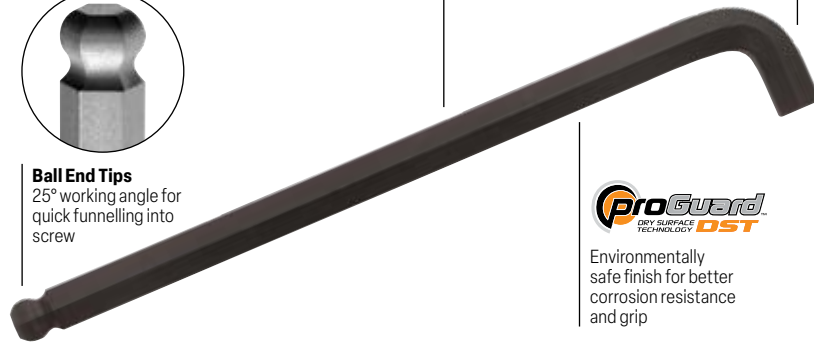

Up to 20% stronger, with more torque and higher wear resistance than standard steel

Stubby Arm
Fits into tight spaces where standard hex keys cannot



Environmentally safe finish for better corrosion resistance and grip

Discount Group: Z1501

Product Information		Item #	Barcode
Size	Pieces		
mm			
Metric Set 9 Pce Set: 1.5, 2, 2.5, 3, 4, 5, 6, 8, 10mm	9	BD16599	037231165994

Product Information		Item #	Barcode
Size	Pieces		
Inch			
Imperial Set 10 Pce Set: 1/16, 5/64, 3/32, 7/64, 1/8, 9/64, 5/32, 3/16, 7/32, 1/4"	10	BD16538	037231165383

L-Wrenches Stubby Double Ball End



Fits into tight spaces standard hex keys cannot. Extra long length provides for greater torque. Inserts into screw and works at a 15° angle. Standard Bondhus ball end on long arm inserts into screw and works at a 25° angle.



BD67099 BD67037



Ball End Tips
25° working angle for quick funnelling into screw

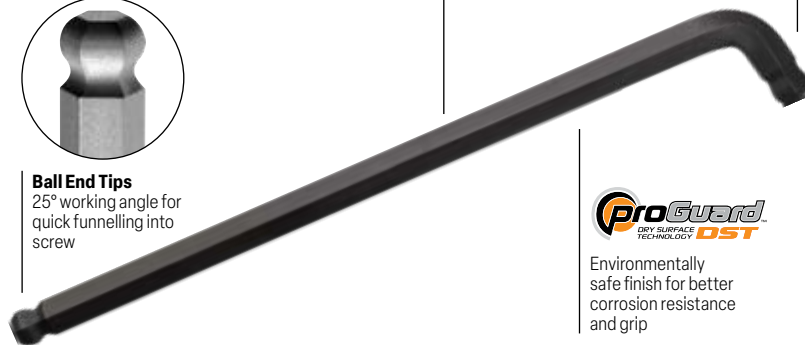

Up to 20% stronger, with more torque and higher wear resistance than standard steel

Stubby Arm
Fits into tight spaces where standard hex keys cannot



Environmentally safe finish for better corrosion resistance and grip

Discount Group: Z1501

Product Information		Item #	Barcode
Size	Pieces		
mm			
Metric Set 9 Pce Set: 1.5, 2, 2.5, 3, 4, 5, 6, 8, 10mm	9	BD67099	037231670993

Product Information		Item #	Barcode
Size	Pieces		
Inch			
Imperial Set 13 Pce Set: .050, 1/16, 5/64, 3/32, 7/64, 1/8, 9/64, 5/32, 3/16, 7/32, 1/4, 5/16, 3/8"	13	BD67037	037231670375

L-Wrenches TORX®



Fits all TORX® and Star screws.
 Broad contact surface provides deep lobe engagement.
 Straight, vertical sidewalls increase tool engagement and virtually eliminates cam-out.

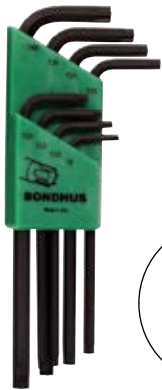

BD31834



TORX® Tips
 Fits all TORX® and Star screws



Up to 20% stronger, with more torque and higher wear resistance than standard steel

TORX® & Star Tip
 Fits all TORX® and Star screws



Environmentally safe finish for better corrosion resistance and grip

Discount Group: Z1501

Product Information				Item #	Barcode
Size	O/A Length	Arm Length	Pieces		
	mm	mm			
T9	74	16	1	BD31809	037231318093
T10	80	19	1	BD31810	037231318109
T15	84	20	1	BD31815	037231318154
T20	91	20	1	BD31820	037231318208
T25	98	22	1	BD31825	037231318253
T27	106	24	1	BD31827	037231318277

Product Information				Item #	Barcode
Size	O/A Length	Arm Length	Pieces		
	mm	mm			
T30	116	26	1	BD31830	037231318307
T40	125	28	1	BD31840	037231318406
Set			8	BD31834	037231318345
8 Pce Set: T9, T10, T15, T20, T25, T27, T30, T40					

L-Wrenches TORX® Tamper Resistant

Fits all TORX® and Star tamper resistant screws.
 Broad contact surface provides deep lobe engagement.
 Straight, vertical sidewalls increase tool engagement and virtually eliminates cam-out.

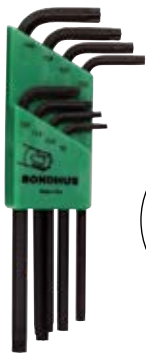

BD32434



Tamper Resistant TORX® Tips
 Precision machined tips transfer more torque to the screw and reduces stripping



Up to 20% stronger, with more torque and higher wear resistance than standard steel

Tamper Resistant TORX® & Tamper Resistant Star Tips
 Fits all TORX® and Star tamper resistant screws



Environmentally safe finish for better corrosion resistance and grip

Discount Group: Z1501

Product Information				Item #	Barcode
Size	O/A Length	Arm Length	Pieces		
	mm	mm			
TR6	55	16	1	BD32406	037231324063
TR7	61	16	1	BD32407	037231324070
TR8	67	16	1	BD32408	037231324087
TR9	74	16	1	BD32409	037231324094
TR10	80	19	1	BD32410	037231324100
TR15	84	20	1	BD32415	037231324155
TR20	91	20	1	BD32420	037231324209
TR25	98	22	1	BD32425	037231324254

Product Information				Item #	Barcode
Size	O/A Length	Arm Length	Pieces		
	mm	mm			
TR27	106	24	1	BD32427	037231324278
TR30	116	26	1	BD32430	037231324308
TR40	125	28	1	BD32440	037231324407
Set			8	BD32434	037231324346
8 Pce Set: TR9, TR10, TR15, TR20, TR25, TR27, TR30, TR40					

Multi-Packs L-Wrenches & GorillaGrip® Fold Up



Assembled from our most popular sets.
 Multiple sets per package.
 Tip selections include Ball End, Hex End and ProHold® Tip Ball End.
 Ideal for mechanics and general purpose.



BD14187



BD14189



BD14130



BD20499



BD20199



BD22199

Discount Group: Z1501

Product Information		Item #	Barcode
Size	Pieces		
16 Pce Set: L-Wrench Ball End 1.5-10mm + Hex End GorillaGrip® (Item # BD10999) + Fold Up 2-8mm (Item # BD12587)	16	BD14187	037231141875
22 Pce Set: L-Wrench Ball End .050-3/8" (Item # BD10937) + Hex End GorillaGrip® Fold Up 5/64-1/4" (Item # BD12589)	22	BD14189	037231141899
34 Pce Set: L-Wrench Ball End .050-3/8" (Item # BD10937) + 1.5-10mm + Hex End GorillaGrip® (Item # BD10999) + Fold Up 5/64-5/32", 1.5-5mm (Item # BD12550)	34	BD14130	037231141301

Product Information		Item #	Barcode
Size	Pieces		
22 Pce Set: ProHold® L-Wrench Ball End .050-3/8" (Item # BD74937) + 1.5-10mm (Item # BD74999)	22	BD20499	037231204990
22 Pce Set: L-Wrench Ball End .050-3/8" (Item # BD10937) + 1.5-10mm (Item # BD10999)	22	BD20199	037231201999
22 Pce Set: L-Wrench Hex End .050-3/8" (Item # BD12137) + 1.5-10mm (Item # BD12199)	22	BD22199	037231221997

GorillaGrip® Fold Up Sets



Patented handle design makes every job faster and easier.
Durable GorillaGrip® handle is stronger than steel handles.
Tool user can adjust tool tension.



Up to 20% stronger, with more torque and higher wear resistance than standard steel

Moulded in 90° stop converts the tool into a time saving speed wrench
Blades open up to 270° from handle. Moulded on stops then blades securely in place



BD12638

BD12897

BD12591



Environmentally safe finish for better corrosion resistance and grip

Discount Group: Z1501

Product Information		Item #	Barcode
Size	Pieces		
8 Pce Set: T6, T7, T8, T9, T10, T15, T20, T25	8	BD12632	037231126322
8 Pce Set: T9, T10, T15, T20, T25, T27, T30, T40	8	BD12634	037231126346
Tamper Resistant TORX® GorillaGrip® Fold Up			
7 Pce Set: TR7, TR8, TR9, TR10, TR15, TR20, TR25	7	BD12636	037231126360
8 Pce Set: TR9, TR10, TR15, TR20, TR25, TR27, TR30, TR40	8	BD12638	037231126384
Ball End GorillaGrip® Fold Up			
5 Pce Set: 3/16, 7/32, 1/4, 5/16, 3/8"	5	BD12894	037231128944
5 Pce Set: 5, 6, 7, 8, 10mm	5	BD12897	037231128975

Product Information		Item #	Barcode
Size	Pieces		
7 Pce Set: 1.5, 2, 2.5, 3, 4, 5, 6mm	7	BD12592	037231125929
7 Pce Set: 2, 2.5, 3, 4, 5, 6, 8mm	7	BD12587	037231125875
6 Pce Set: 3, 4, 5, 6, 8, 10mm	6	BD12595	037231125950
9 Pce Set: .050, 1/16, 5/64, 3/32, 7/64, 1/8, 9/64, 5/32, 3/16"	9	BD12591	037231125912
9 Pce Set: 5/64, 3/32, 7/64, 1/8, 9/64, 5/32, 3/16, 7/32, 1/4"	9	BD12589	037231125899
5 Pce Set: 3/16, 7/32, 1/4, 5/16, 3/8"	5	BD12585	037231125851
12 Pce Set: 5/64, 3/32, 7/64, 1/8, 9/64, 5/32, 1.5, 2, 2.5, 3, 4, 5mm	12	BD12550	037231125509

GorillaGrip® Fold Up Utility & Multi-Packs



Wide selection of tool tips.
World's strongest handle.
Speed-Wrench feature.
Tools open from both the top and bottom.
Moulded-in 90° stop.
Patented spacers between tools.

Up to 20% stronger, with more torque and higher wear resistance than standard steel



Environmentally safe finish for better corrosion resistance and grip



BD12522

BD12544

BD12533

Discount Group: Z1501

Product Information		Item #	Barcode
Size	Pieces		
Utility GorillaGrip® Fold Up			
5 Pce Set: PH #1, Slotted 3/16", Hex 4, 5, 6mm	5	BD12540	037231125400

Product Information		Item #	Barcode
Size	Pieces		
Multi Pack GorillaGrip® Fold Up			
16 Pce Set: 5/64-1/4" (Item # 12589) + 2-8mm (Item # 12587)	16	BD12522	037231125226
15 Pce Set: 2-8mm (Item # 12587) + T9-T40 (Item # 12634)	15	BD12544	037231125448
24 Pce Set: 5/64-1/4" (Item # 12589) + 2-8mm (Item # 12587) + T9-T40 (Item # 12634)	24	BD12533	037231125332

T-Handles Ball End



Solid steel handles.
Welded handle/blade connection.
Ergonomic handle design.
Flywheel effect saves time.
Smooth, non-porous handle coating.
Handle coating extends along blade.



BD13189

BD13190



Ball End Tips
25° working angle for quick funnelling into screw



Up to 20% stronger, with more torque and higher wear resistance than standard steel



Environmentally safe finish for better corrosion resistance and grip

Sizes Printed On Handles
For easy and quick section



Ergonomic Handle
Welded directly to blade for durable and comfortable grip

Discount Group: Z1501

Product Information				Item #	Barcode
Size	O/A Length	Handle Length	Pieces		
mm	mm	mm			
Metric (Tagged)					
2.0	150	76	1	BD53252 [†]	037231532529
2.5	172	76	1	BD53254 [†]	037231532543
3.0	196	76	1	BD53256 [†]	037231532567
4.0	220	76	1	BD53160	037231531607
5.0	246	102	1	BD53164	037231531645
6.0	266	102	1	BD53168	037231531683
8.0	285	127	1	BD53172	037231531720
10.0	307	127	1	BD53176	037231531768
Metric Sets					
5 Pce Set: 4, 5, 6, 8, 10mm			5	BD13148	037231131487
8 Pce Set: 2, 2.5, 3, 4, 5, 6, 8, 10mm			8	BD13187	037231131876
8 Pce Set with Stand: 2, 2.5, 3, 4, 5, 6, 8, 10mm			8	BD13189	037231131890

Product Information				Item #	Barcode
Size	O/A Length	Handle Length	Pieces		
Inch	mm	mm			
Imperial (Tagged)					
3/32"	154	76	1	BD53205 [†]	037231532055
7/64"	173	76	1	BD53206 [†]	037231532062
1/8"	192	76	1	BD53207 [†]	037231532079
9/64"	211	76	1	BD53208 [†]	037231532086
5/32"	231	76	1	BD53109	037231531096
3/16"	250	102	1	BD53110	037231531102
7/32"	262	102	1	BD53111	037231531119
1/4"	275	102	1	BD53112	037231531126
5/16"	289	127	1	BD53113	037231531133
3/8"	300	127	1	BD53114	037231531140
Imperial Sets					
6 Pce Set: 5/32, 3/16, 7/32, 1/4, 5/16, 3/8"			6	BD13146	037231131463
10 Pce Set: 3/32, 7/64, 1/8, 9/64, 5/32, 3/16, 7/32, 1/4, 5/16, 3/8"			10	BD13138	037231131388
10 Pce Set with Stand: 3/32, 7/64, 1/8, 9/64, 5/32, 3/16, 7/32, 1/4, 5/16, 3/8"			10	BD13190	037231131906

[†]Hex Tip

T-Handles Hex End



- Solid steel handles.
- Welded handle/blade connection.
- Ergonomic handle design.
- Flywheel effect saves time.
- Smooth, non-porous handle coating.
- Handle coating extends along blade.



BD13389

BD13390

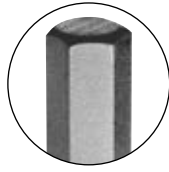

Hex End Tips
Precision machined for superior fit



Up to 20% stronger, with more torque and higher wear resistance than standard steel



Environmentally safe finish for better corrosion resistance and grip



Sizes Printed On Handles
For easy and quick section

Ergonomic Handle
Welded directly to blade for durable and comfortable grip

Discount Group: Z1501

Product Information				Item #	Barcode
Size	O/A Length	Handle Length	Pieces		
mm	mm	mm			
Metric (Tagged) 229mm					
2.0	229	76	1	BD15352	037231153526
2.5	229	76	1	BD15354	037231153540
3.0	229	76	1	BD15356	037231153564
4.0	229	76	1	BD15360	037231153601
5.0	229	102	1	BD15364	037231153649
6.0	229	102	1	BD15368	037231153687
8.0	229	127	1	BD15372	037231153724
10.0	229	127	1	BD15376	037231153762
Set					
6 Pce Set: 2, 2.5, 3, 4, 5, 6mm			6	BD15348	037231153489
Metric (Tagged) 356mm					
3.0	356	76	1	BD16456	037231164560
4.0	356	76	1	BD16460	037231164607
5.0	356	102	1	BD16464	037231164645
6.0	356	102	1	BD16468	037231164683
8.0	356	127	1	BD16472	037231164720
Metric (Tagged) Graduated Length					
2.0	100	76	1	BD13352	037231133528
2.5	110	76	1	BD13354	037231133542
3.0	120	76	1	BD13356	037231133566
4.0	136	76	1	BD13360	037231133603
5.0	150	102	1	BD13364	037231133641
6.0	173	102	1	BD13368	037231133689
8.0	202	127	1	BD13372	037231133726
10.0	232	127	1	BD13376	037231133764
Metric Sets					
8 Pce Set: 2, 2.5, 3, 4, 5, 6, 8, 10mm			8	BD13387	037231133870
8 Pce Set with Stand: 2, 2.5, 3, 4, 5, 6, 8, 10mm			8	BD13389	037231133894

Product Information				Item #	Barcode
Size	O/A Length	Handle Length	Pieces		
Inch	mm	mm			
Imperial (Tagged)					
3/32"	105	76	1	BD13305	037231133054
7/64"	112	76	1	BD13306	037231133061
1/8"	118	76	1	BD13307	037231133078
9/64"	124	76	1	BD13308	037231133085
5/32"	132	76	1	BD13309	037231133092
3/16"	141	102	1	BD13310	037231133108
7/32"	154	102	1	BD13311	037231133115
1/4"	165	102	1	BD13312	037231133122
5/16"	189	127	1	BD13313	037231133139
3/8"	211	127	1	BD13314	037231133146
Imperial Sets					
8 Pce Set: 3/32, 7/64, 1/8, 9/64, 5/32, 3/16, 7/32, 1/4"			8	BD13332	037231133320
10 Pce Set with Stand: 3/32, 7/64, 1/8, 9/64, 5/32, 3/16, 7/32, 1/4, 5/16, 3/8"			10	BD13390	037231133900

T-Handles TORX®



Fits all TORX® and Star screws.
Solid steel handles.
Welded handle/blade connection.
Ergonomic handle design.
Flywheel effect saves time.
Smooth, non-porous handle coating.



BD33034

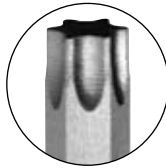

TORX® Tips
Fits all TORX® and Star screws



Up to 20% stronger, with more torque and higher wear resistance than standard steel



Environmentally safe finish for better corrosion resistance and grip



Sizes Printed On Handles
For easy and quick section

Ergonomic Handle
Welded directly to blade for durable and comfortable grip

Discount Group: Z1501

Product Information				Item #	Barcode
Size	O/A Length	Handle Length	Pieces		
	mm	mm			
T40	199	102	1	BD33040	037231330408

Product Information				Item #	Barcode
Size	O/A Length	Handle Length	Pieces		
	mm	mm			
8 Pce Set: T9, T10, T15, T20, T25, T27, T30, T40			8	BD33034	037231330347

T-Handles ProHold® TORX®



Fits all TORX® and Star screws.
Holds screw tight on the tool every time.
Button is non-magnetic.
Welded handle/blade connection.



ProHold® Tips
Holds screw tight on the tool every time



Up to 20% stronger, with more torque and higher wear resistance than standard steel



Environmentally safe finish for better corrosion resistance and grip



Sizes Printed On Handles
For easy and quick section

Ergonomic Handle
Welded directly to blade for durable and comfortable grip

Discount Group: Z1501

Product Information				Item #	Barcode
Size	O/A Length	Handle Length	Pieces		
	mm	mm			
TR9	155	76	1	BD74009	037231740092
TR10	161	76	1	BD74010	037231740108
TR15	168	76	1	BD74015	037231740153
TR20	174	76	1	BD74020	037231740207

Product Information				Item #	Barcode
Size	O/A Length	Handle Length	Pieces		
	mm	mm			
TR25	180	76	1	BD74025	037231740252
TR27	187	102	1	BD74027	037231740276
TR30	193	102	1	BD74030	037231740306

Screwdrivers Ball End



Ball End inserts into screw at a 25° angle.
Ergonomic non-slip grip handle design.
Two component handle with tough inner core and cushioned rubber exterior.
Anti-roll design.

Non-Slip Grip
Generates maximum torque even when wet or oily



BD10699



Ball End Tips
25° working angle for quick funnelling into screw



Up to 20% stronger, with more torque and higher wear resistance than standard steel



Durable thermoplastic core wrapped in cushioned rubber for increased comfort and torque



Environmentally safe finish for better corrosion resistance and grip

Discount Group: Z1501

Product Information				Item #	Barcode
Size	O/A Length	Handle Length	Pieces		
mm	mm	mm			
Metric (Long) (Packaged)					
2.0	157	102	1	BD10752	037231107529
2.5	171	110	1	BD10754	037231107543
3.0	247	158	1	BD10756	037231107567
4.0	288	179	1	BD10760	037231107604
5.0	308	198	1	BD10764	037231107642
6.0	341	218	1	BD10768	037231107680
8.0	360	237	1	BD10772	037231107727
10.0	382	259	1	BD10776	037231107765
Metric (Standard) (Tagged)					
1.5	120	66	1	BD40650	037231406509
2.0	127	72	1	BD40652	037231406523
2.5	130	69	1	BD40654	037231406547
3.0	171	83	1	BD40656	037231406561
4.0	205	98	1	BD40660	037231406608
5.0	219	109	1	BD40664	037231406646
6.0	260	137	1	BD40668	037231406684
8.0	298	175	1	BD40672	037231406721
10.0	307	184	1	BD40676	037231406769
Metric Sets					
6 Pce Set: 1.5, 2, 2.5, 3, 4, 5mm			6	BD10686	037231106867
9 Pce Set: 1.5, 2, 2.5, 3, 4, 5, 6, 8, 10mm			9	BD10699	037231106997
8 Pce Set (Long): 2, 2.5, 3, 4, 5, 6, 8, 10mm			8	BD10733	037231107338

Product Information				Item #	Barcode
Size	O/A Length	Handle Length	Pieces		
Inch	mm	mm			
Imperial (Standard) (Tagged)					
.050"	104	60	1	BD40602	037231406028
1/16"	118	64	1	BD40603	037231406035
5/64"	122	67	1	BD40604	037231406042
3/32"	132	71	1	BD40605	037231406059
7/64"	136	74	1	BD40606	037231406066
1/8"	168	80	1	BD40607	037231406073
9/64"	171	83	1	BD40608	037231406080
5/32"	201	91	1	BD40609	037231406097
3/16"	204	94	1	BD40610	037231406103
7/32"	230	107	1	BD40611	037231406110
1/4"	249	126	1	BD40612	037231406127
5/16"	265	142	1	BD40613	037231406134
3/8"	287	164	1	BD40614	037231406141
Imperial Set					
13 Pce Set: .050, 1/16, 5/64, 3/32, 7/64, 1/8, 9/64, 5/32, 3/16, 7/32, 1/4, 5/16, 3/8"			13	BD10637	037231106379

Screwdrivers TORX® Tamper Resistant



Fits all TORX® and Star tamper resistant screws.
 Burr free tool tips help tools seat fully in screw head.
 Precision machined tips transfer more torque to the screw and reduces stripping.



Tamper Resistant TORX® Tips
 Precision machined tips transfer more torque to the screw and reduces stripping



Up to 20% stronger, with more torque and higher wear resistance than standard steel

Non-Slip Grip
 Generates maximum torque even when wet or oily



Environmentally safe finish for better corrosion resistance and grip



Durable thermoplastic core wrapped in cushioned rubber for increased comfort and torque

Discount Group: Z1501

Product Information				Item #	Barcode
Size	O/A Length	Shank Length	Pieces		
	mm	mm			
TR6	163	108	1	BD33806	037231338060
TR7	169	114	1	BD33807	037231338077
TR8	182	121	1	BD33808	037231338084
TR9	186	124	1	BD33809	037231338091
TR10	189	128	1	BD33810	037231338107
TR15	219	131	1	BD33815	037231338152
TR20	248	138	1	BD33820	037231338206
TR25	253	144	1	BD33825	037231338251
TR27	270	147	1	BD33827	037231338275
TR30	276	153	1	BD33830	037231338305
TR40	282	159	1	BD33840	037231338404

Product Information				Item #	Barcode
Size	O/A Length	Shank Length	Pieces		
	mm	mm			
Sets					
8 Pce Set: TR9, T R10, TR15, TR20, TR25, TR27, TR30, TR40			8	BD33834	037231338343

Wing & Flag Tool TORX®



Fits all TORX® and TORX PLUS® screws.
 Fits all Star and Star Plus screws.
 ComfortGrip Handles – soft rubber outer coating for maximum comfort and grip.
 Broad contact surface provides deep lobe engagement.
 Straight, vertical sidewalls increase tool engagement and virtually eliminates cam-out.



Soft rubber outer coating for maximum comfort and grip

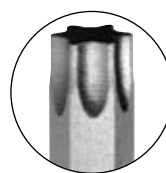

Multi-Fit
 Fits all TORX® and TORX Plus®, Star and Star Plus screws



BD34445



BD34745

Discount Group: Z1501

Product Information		Item #	Barcode
Size	Pieces		
7 Pce TORX® Flag Tools Set: T6, T7, T8, T9, T10, T15, T20	7	BD34445	037231344450

Product Information		Item #	Barcode
Size	Pieces		
7 Pce TORX® Wing Tools Set: T6, T7, T8, T9, T10, T15, T20	7	BD34745	037231347451

Hex Pro TORX® & Hex Tip



Fits Inch and Metric Hex, TORX®, and Star screws.
 Heat treated high quality industrial tool steel.
 Long handles for extra reach.
 Matte chrome finish to prevent corrosion.

Pivot Head
 Hex and Star wrenches allow users to pivot around obstacles without removing tool



BD00055

BD00040

BD00051

Engineered Joints
 Joint are made as small as possible without weakening the tool

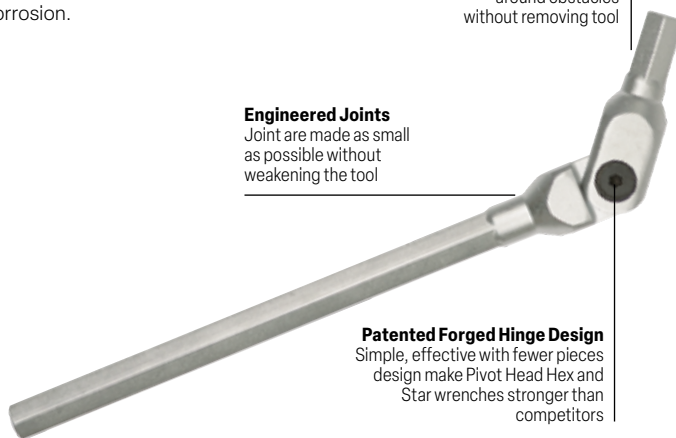

Patented Forged Hinge Design
 Simple, effective with fewer pieces design make Pivot Head Hex and Star wrenches stronger than competitors

Discount Group: Z1501

Product Information		Item #	Barcode
Size	Pieces		
Hex Tip			
Metric			
4.0	1	BD88760	855782887604
5.0	1	BD88764	855782887642
6.0	1	BD88768	855782887680
8.0	1	BD88772	855782887727
10.0	1	BD88776	855782887765
Imperial			
3/16"	1	BD88710	855782887109
7/32"	1	BD88711	855782887116
1/4"	1	BD88712	855782887123
5/16"	1	BD88713	855782887130
3/8"	1	BD88714	855782887147

Product Information		Item #	Barcode
Size	Pieces		
Torx Tip			
T25	1	BD88725	855782887253
T30	1	BD88730	855782887307
T40	1	BD88740	855782887406
T45	1	BD88745	855782887451
T50	1	BD88750	855782887505
Sets			
5 Pce Set: T25, T30, T40, T45, T50	5	BD00055	855782000553
5 Pce Set: 3/16, 7/32, 1/4, 5/16, 3/8"	5	BD00040	855782000409
5 Pce Set: 4, 5, 6, 8, 10mm	5	BD00051	855782000515

Socket Bits Hex End



Bits fit any standard six point socket.
 Bits are suitable for use with impact sockets.
 Chamfered tool tips eliminate burrs and help tools seat in screw head.
 Sharp corners transfer more torque to the screw and reduce stripping.
 Precision machined for ease of use and superior fit.

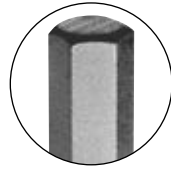

Hex End Tips
 Precision machined for superior fit



Up to 20% stronger, with more torque and higher wear resistance than standard steel



Environmentally safe finish for better corrosion resistance and grip

Discount Group: Z1501

Sizes	Drive	Item #	Barcode
Socket & Bits			
19mm Prohold Hex Bit 6" inch, 1/2" SKT	1/2"	BD43688	037231436889

Power Bits Ball End



Fits all 1/4" drive bit holders.
 Ball End inserts into a screw at a 25° angle.
 Ball End saves time by quickly funnelling tool into screw.
 Superior Ball End strength and working angle.
 Works in hard to reach places.



BD10868

1/4" Hex Shank
 Suitable for impact drivers



Up to 20% stronger, with more torque and higher wear resistance than standard steel



Environmentally safe finish for better corrosion resistance and grip



Ball End Tips
 25° working angle for quick funnelling into screw

Discount Group: Z1501

Product Information		Item #	Barcode
Size	Pieces		
Metric	mm		
2.0	76	BD10852	037231108526
2.5	76	BD10854	037231108540
3.0	76	BD10856	037231108564
4.0	76	BD10860	037231108601
5.0	76	BD10864	037231108649

Product Information		Item #	Barcode
Size	Pieces		
Metric	mm		
6.0	76	BD10868	037231108687
8.0	76	BD10872	037231108724
10.0	76	BD10876	037231108762
12.0	76	BD10880	037231108809

